

How to Measure Trolley/Tray Cart Covers - Design 5

Measurement Instruction

- ✓ Give exact measurement from edge to edge.
- ✓ We add 2.5 to 5 cm leeway on the given width/depth for easy pull-in and pull-out.
- ✓ The height dimensions will remain same as provided by you.

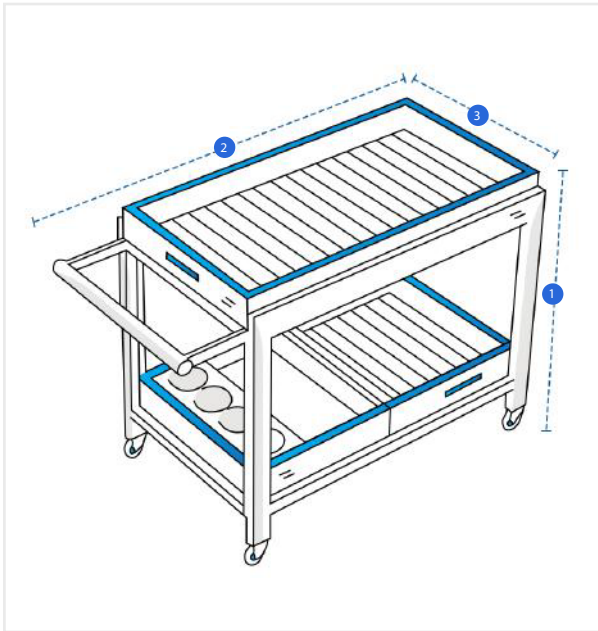

Measurement (cm)

1. Height

2. Width

3. Depth

1. Height:

Height of the Trolley/Tray Cart

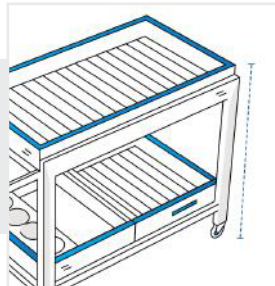

2. Width:

Width of the Trolley/Tray Cart

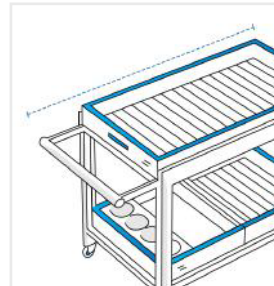

3. Depth:

Depth of the Trolley/Tray Cart

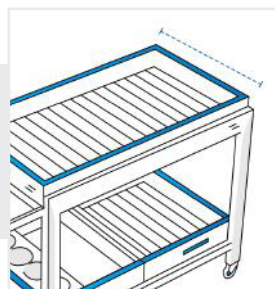

We encourage you to upload the image of the article you need the cover for - this helps our team ensure covers are designed keeping your requirements in mind.