

How to Measure Tractor Covers

Measurement Instruction

- ✓ Give exact measurement from edge to edge.
- ✓ We add 2.5 to 5 cm leeway on the given width/depth for easy pull-in and pull-out.
- ✓ The height dimensions will remain same as provided by you.

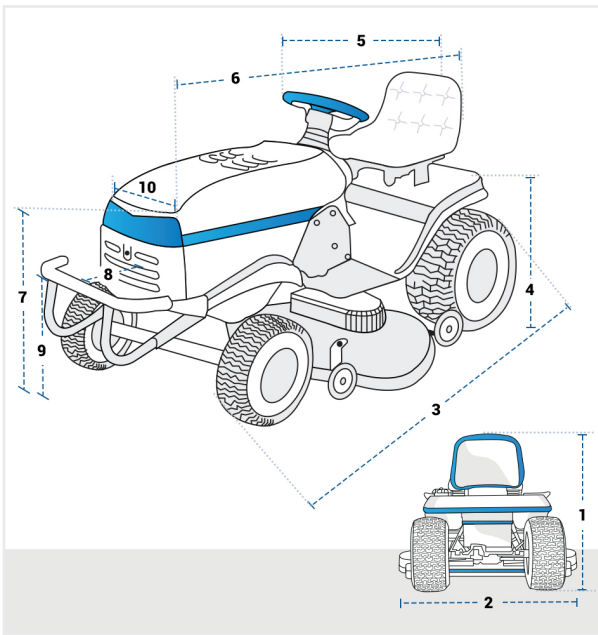

Measurement (cm)

1. Back Height	<input type="text"/>	2. Back Width Including Side Parts	<input type="text"/>
3. Total Depth without Bumper Guard	<input type="text"/>	4. Height#1	<input type="text"/>
5. Depth From Steering To Seat	<input type="text"/>	6. Depth From Bonnet To Seat	<input type="text"/>
7. Height From Ground To Bonnet	<input type="text"/>	8. Depth From Bumper Guard To Bonnet	<input type="text"/>
9. Height From Ground To Bumper Guard	<input type="text"/>	10. Bonnet Width	<input type="text"/>

1. Back Height:
Back Height of the Tractor

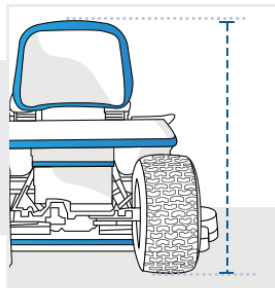

2. Back Width Including Side Parts:
Back Width Including Side Parts of the Tractor

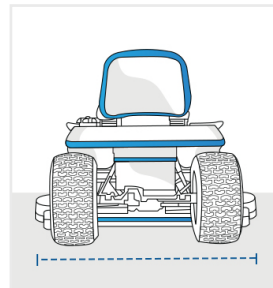

3. Total Depth without Bumper Guard:
Total Depth of the Tractor

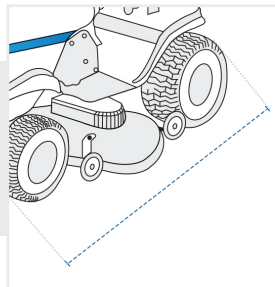

4. Height#1:
Height (Side #1)

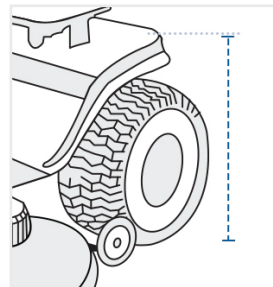

5. Depth From Steering To Seat:
Depth From Steering To Seat of the Tractor

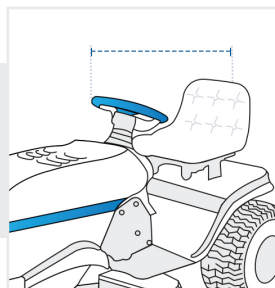

6. Depth From Bonnet To Seat:
Depth From Bonnet To Seat of the Tractor

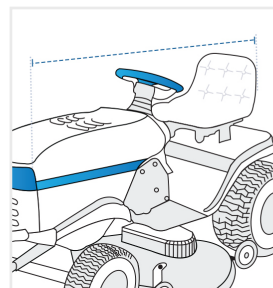

7. Height From Ground To Bonnet:

Height From Ground To Bonnet of the Tractor

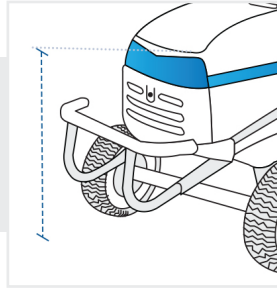

8. Depth From Bumper Guard To Bonnet:

Depth From Bumper Guard To Bonnet of the Tractor

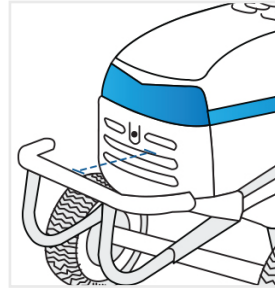

9. Height From Ground To Bumper Guard:

Height From Ground To Bumper Guard of the Tractor

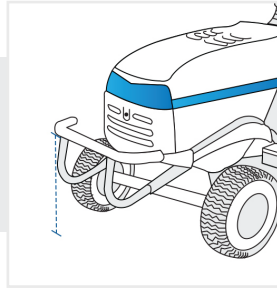

10. Bonnet Width:

Bonnet Width of the Tractor

