

## How to Measure Recumbent Exercise Bike Covers

### Measurement Instruction

- ✓ Give exact measurement from edge to edge.
- ✓ We add 2.5 to 5 cm leeway on the given width/depth for easy pull-in and pull-out.
- ✓ The height dimensions will remain same as provided by you.

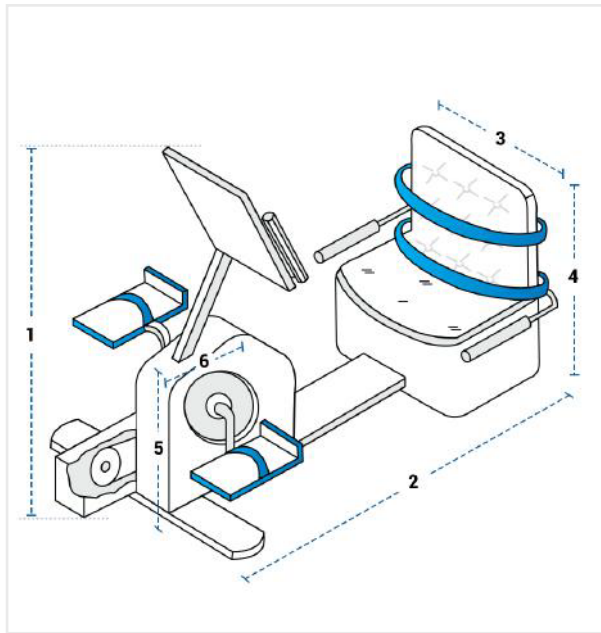

### Measurement (cm)

1. Total H eight

2. Depth

3. Width

4. Back Height

5. Front Height

6. Front Depth

**1. total Height:**  
Total Height of the Recumbent Exercise Bike

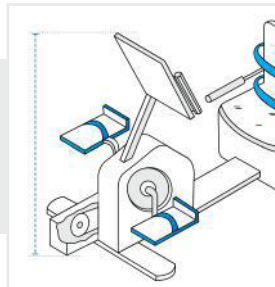

**2. Depth:**  
Depth of the Recumbent Exercise Bike

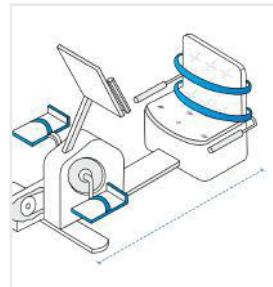

**3. Width:**  
Width of the Recumbent Exercise Bike

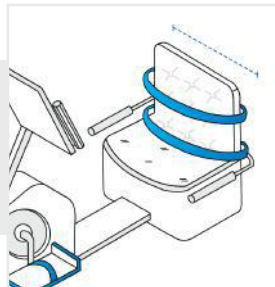

**4. Back Height:**  
Back Height of the Recumbent Exercise Bike

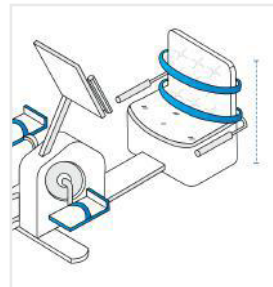

**5. Front Height:**  
Front height of the Recumbent Exercise Bike

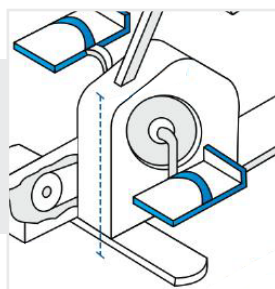

**6. Front Depth:**  
Front Depth of the Recumbent Exercise Bike

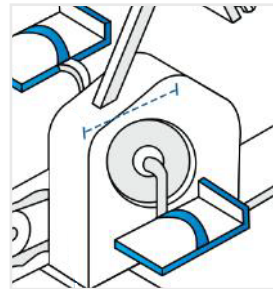

We encourage you to upload the image of the article you need the cover for - this helps our team ensure covers are designed keeping your requirements in mind.