

## How to Measure Outdoor Pizza Oven Covers

### Measurement Instruction

- ✓ Give exact measurement from edge to edge.
- ✓ We add 2.5 to 5 cm leeway on the given width/depth for easy pull-in and pull-out.
- ✓ The height dimensions will remain same as provided by you.

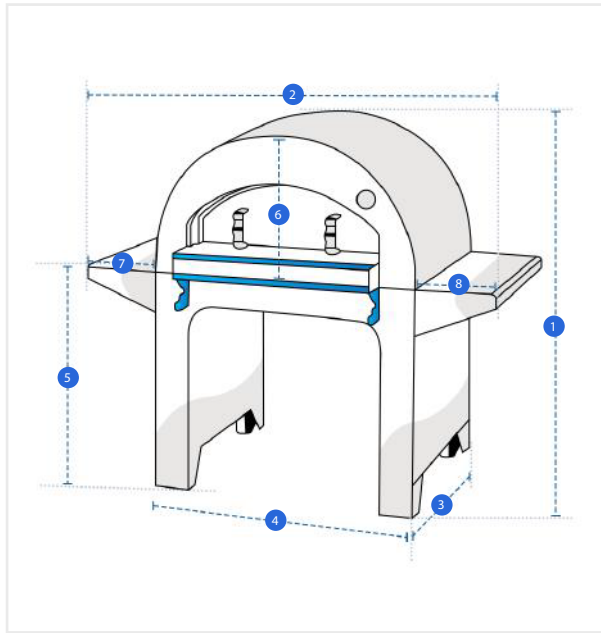

### Measurement (cm)

1. Height	<input type="text"/>	2. Width	<input type="text"/>
3. Depth	<input type="text"/>	4. Width #2	<input type="text"/>
5. Height From Ground To Shelf	<input type="text"/>	6. Height From Shelf To Top	<input type="text"/>
7. Left-Arm Width	<input type="text"/>	8. Right-Arm Width	<input type="text"/>

**1. Height:**  
Height of the Outdoor Pizza Oven

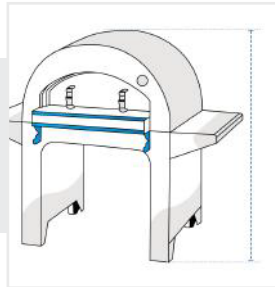

**2. Width:**  
Width (#1)

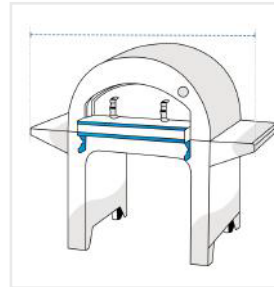

**3. Depth:**  
Depth of the Outdoor Pizza Oven

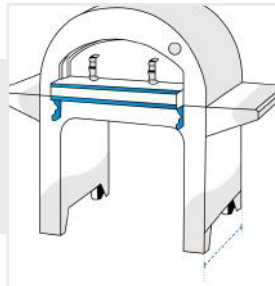

**4. Width #2:**  
Width (Side #2)

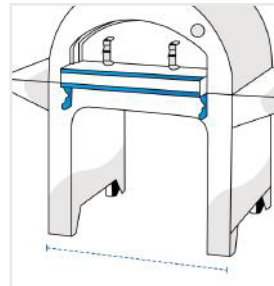

**5. Height From Ground To Shelf:**  
Height From Ground To Shelf

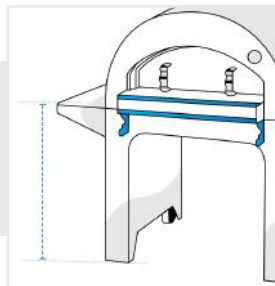

**6. Height From Shelf To Top:**  
Height From Shelf To Top

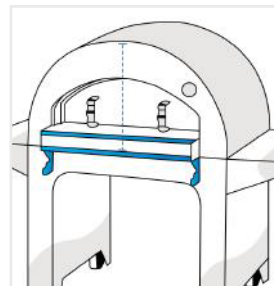

**7. Left-Arm Width:**

Left Arm Width

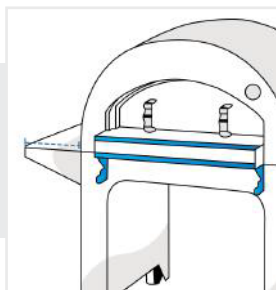

**8. Right-Arm Width:**

Right Arm Width

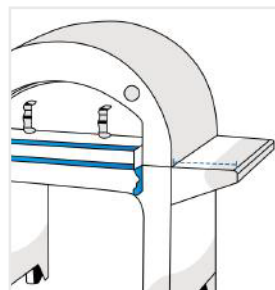

We encourage you to upload the image of the article you need the cover for - this helps our team ensure covers are designed keeping your requirements in mind.