

## How to Measure Outdoor Island Kitchen Covers

### Measurement Instruction

- ✓ Give exact measurement from edge to edge.
- ✓ We add 2.5 to 5 cm leeway on the given width/depth for easy pull-in and pull-out.
- ✓ The height dimensions will remain same as provided by you.

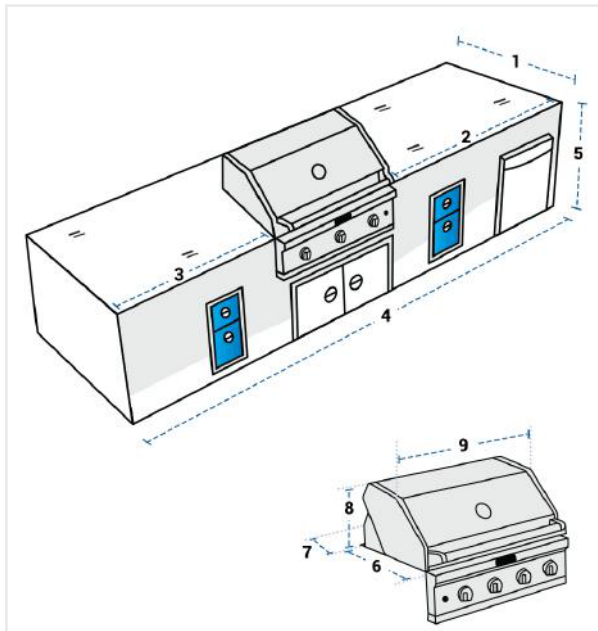

### Measurement (cm)

1. Total Depth	<input type="text"/>	2. Front Right Side Width	<input type="text"/>
3. Front Left Side Width	<input type="text"/>	4. Total Width	<input type="text"/>
5. Counter Height	<input type="text"/>	6. Depth of the Grill Hood Incl Handle & Burner Knobs	<input type="text"/>
7. From Counter Edge to Grill Edge	<input type="text"/>	8. Height of the Grill	<input type="text"/>
9. Width of the Grill	<input type="text"/>		

**1. Total Depth:**  
Total Depth of the Cover

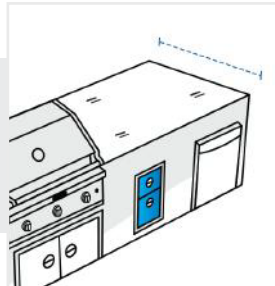

**2. Front Right Side Width:**  
Front Right side width from Grill Hood to Right side

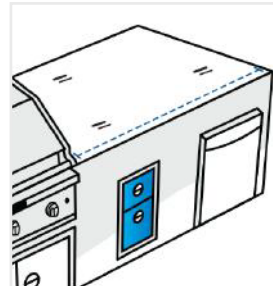

**3. Front Left Side Width:**  
Front Left side width from Grill Hood to Left side

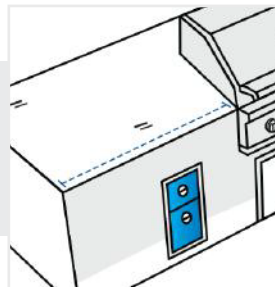

**4. Total Width:**  
Total Width of Kitchen

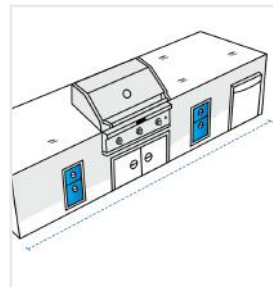

**5. Counter Height :**  
Height of the Kitchen Table (Do not include Grill Hood Height)

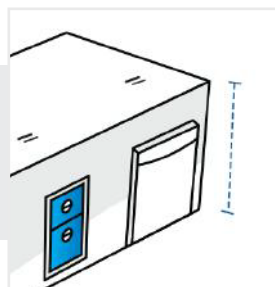

**6. Depth of the Grill Hood Incl Handle & Burner Knobs:**  
Depth of the Grill Hood Including Handle & Burner Knobs

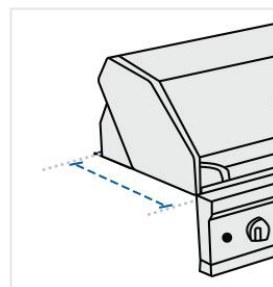

**7. From Counter Edge to Grill Edge:**  
From Counter Edge to Grill Edge

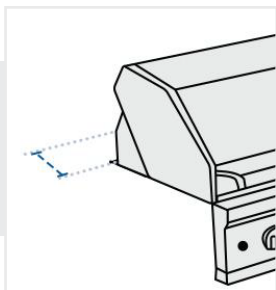

**8. Height of the Grill:**  
Height of the Grill

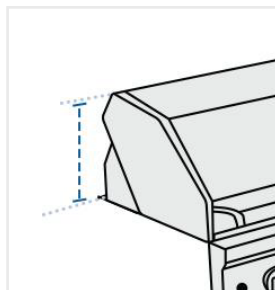

**9. Width of the Grill:**  
Width of the Grill

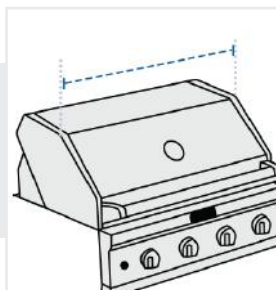

We encourage you to upload the image of the article you need the cover for - this helps our team ensure covers are designed keeping your requirements in mind.