

How to Measure Outdoor Pizza Oven Covers - Design 6

Measurement Instruction

- ✓ Give exact measurement from edge to edge.
- ✓ We add 2.5 to 5 cm leeway on the given width/depth for easy pull-in and pull-out.
- ✓ The height dimensions will remain same as provided by you.

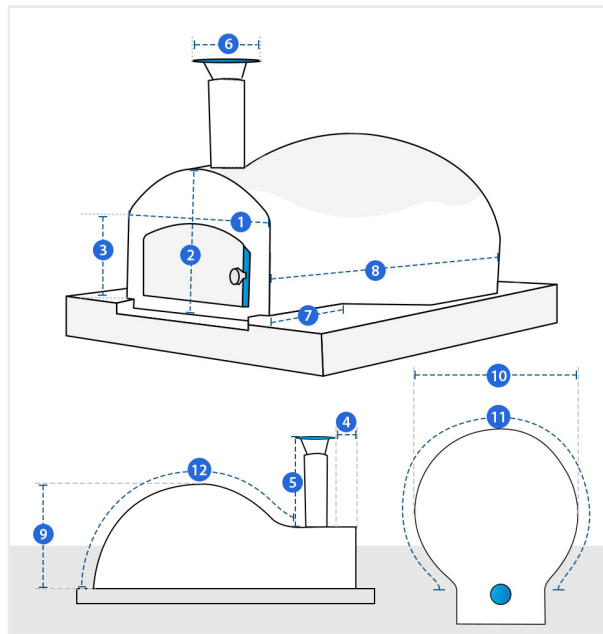

Measurement (cm)

1. Width	<input type="text"/>	2. Height #1	<input type="text"/>
3. Height #2	<input type="text"/>	4. Depth from front to chimney	<input type="text"/>
5. Height of Chimney	<input type="text"/>	6. Dia of Chimney	<input type="text"/>
7. Depth #1	<input type="text"/>	8. Total Depth	<input type="text"/>
9. Height #3	<input type="text"/>	10. Width #1	<input type="text"/>
11. Back Circumference	<input type="text"/>	12. Top Circumference	<input type="text"/>

1. Width:
Width of the Outdoor Pizza Oven

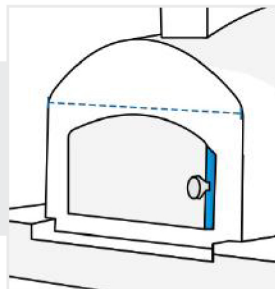

2. Height#1:
Height (side #1) of the Outdoor Pizza Oven

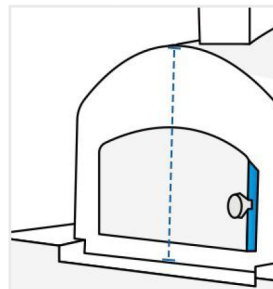

3. Height#2:
Height (side #2) of the Outdoor Pizza Oven

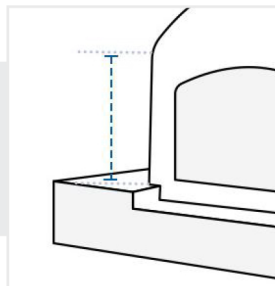

4. Depth from front to chimney:
Depth from front to chimney of the Outdoor Pizza Oven

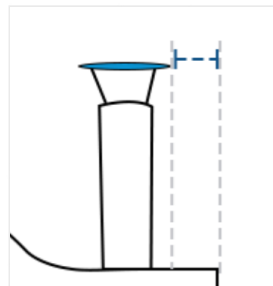

5. Height of Chimney:
Height of Chimney of the Outdoor Pizza Oven

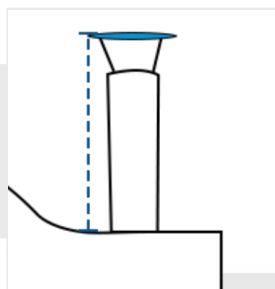

6. Dia of Chimney:
Dia of Chimney of the Outdoor Pizza Oven

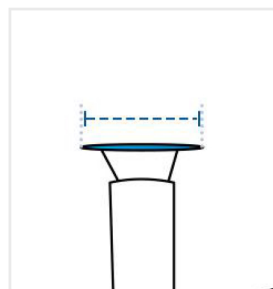

7. Depth #1:

Depth (side #1) of the Outdoor Pizza Oven

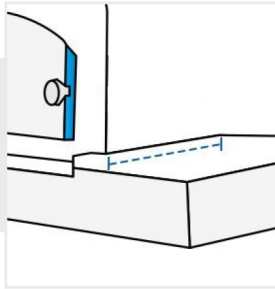

8. Total Depth:

Total Depth of the Outdoor Pizza Oven

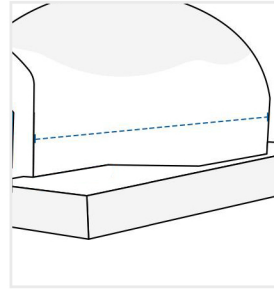

9. Height #3:

Height (side #3) of the Outdoor Pizza Oven

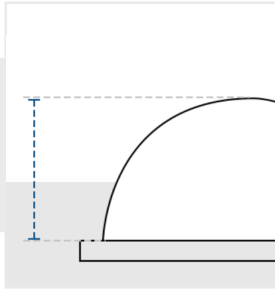

10. Width #1:

Width (side #1) of the Outdoor Pizza Oven

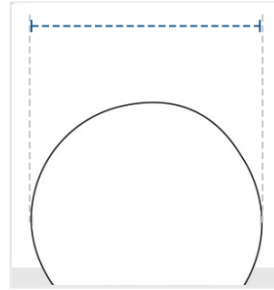

11. Back Circumference:

Back Circumference(max) of the Outdoor Pizza Oven

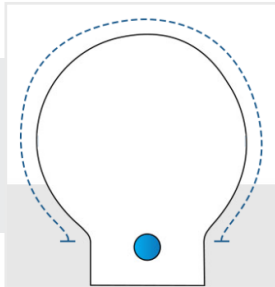

12. Top Circumference:

Top Circumference of the Outdoor Pizza Oven

