

How to Measure L-shaped Island Kitchen Covers - Right

Measurement Instruction

- ✓ Give exact measurement from edge to edge.
- ✓ We add 2.5 to 5 cm leeway on the given width/depth for easy pull-in and pull-out.
- ✓ The height dimensions will remain same as provided by you.

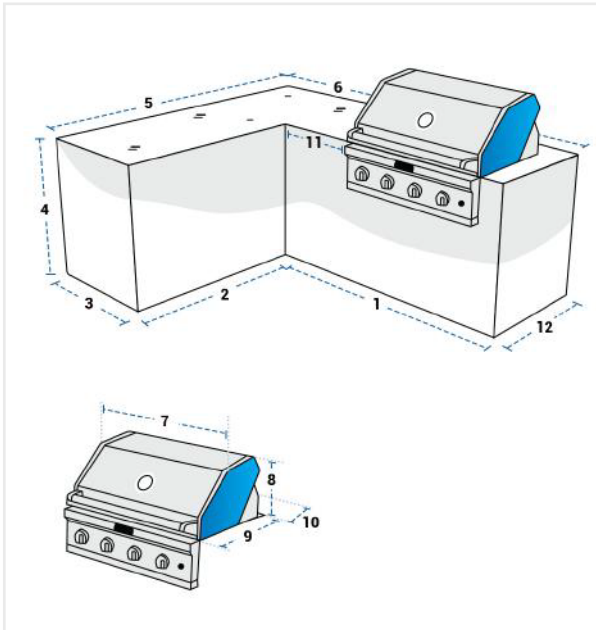

Measurement (cm)

1. Front Right Width	<input type="text"/>	2. Front Left Width	<input type="text"/>
3. Left Depth	<input type="text"/>	4. Height	<input type="text"/>
5. Back Left Width	<input type="text"/>	6. Back Right Width	<input type="text"/>
7. Grill Hood Width	<input type="text"/>	8. Grill Hood Height	<input type="text"/>
9. Grill Hood Depth Incl Handle & Burner Knobs	<input type="text"/>	10. Counter Edge to Grill	<input type="text"/>
11. Corner to Grill	<input type="text"/>	12. Right Depth	<input type="text"/>

1. Front Right Width:
Front width of the Kitchen - Right side

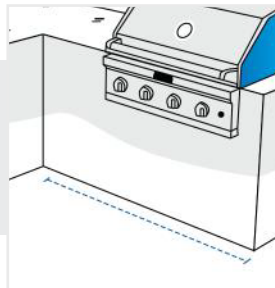

2. Front Left Width:
Front width of the Kitchen - Left side

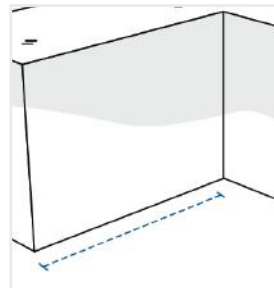

3. Left Depth:
Depth of Kitchen - Left Side

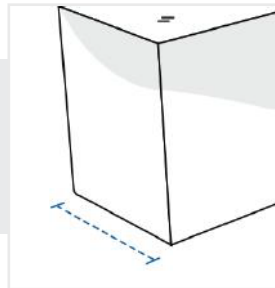

4. Height:
Height of the Kitchen (Excluding Grill hood - Only Kitchen Table)

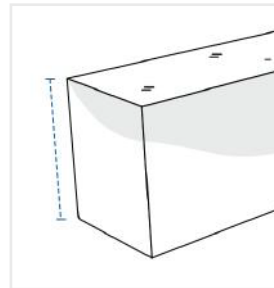

5. Back Left Width:
Back Width of Kitchen - Left Side

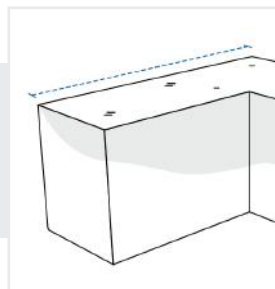

6. Back Right Width:
Back Width of Kitchen - Right Side

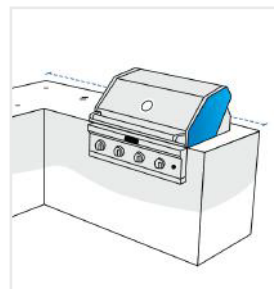

7. Grill Hood Width:
Width of the Grill Hood

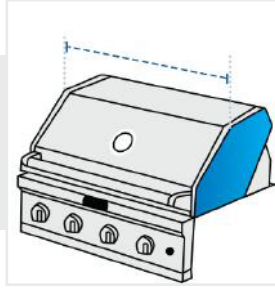

8. Grill Hood Height:
Height of the Grill hood from Kitchen Table

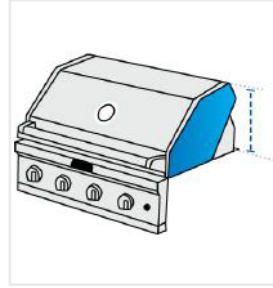

9. Grill Hood Depth Incl Handle & Burner Knobs:
Grill Hood Depth Incl Handle & Burner Knobs

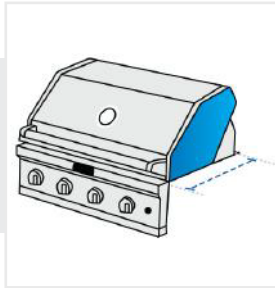

10. Counter Edge to Grill:
Counter Edge to Grill

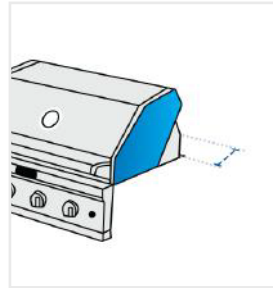

11. Corner to Grill:
Distance between Right end of table to Grill

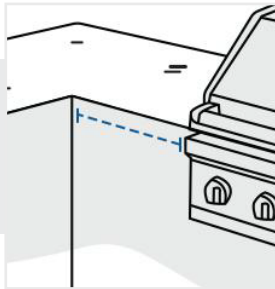

12. Right Depth:
Depth of Kitchen - Right Side

