

## How to Measure Golf Cart Covers?

### Measurement Instruction

- ✓ Give exact measurement from edge to edge.
- ✓ We add 2.5 to 5 cm leeway on the given width/depth for easy pull-in and pull-out.
- ✓ The height dimensions will remain same as provided by you.

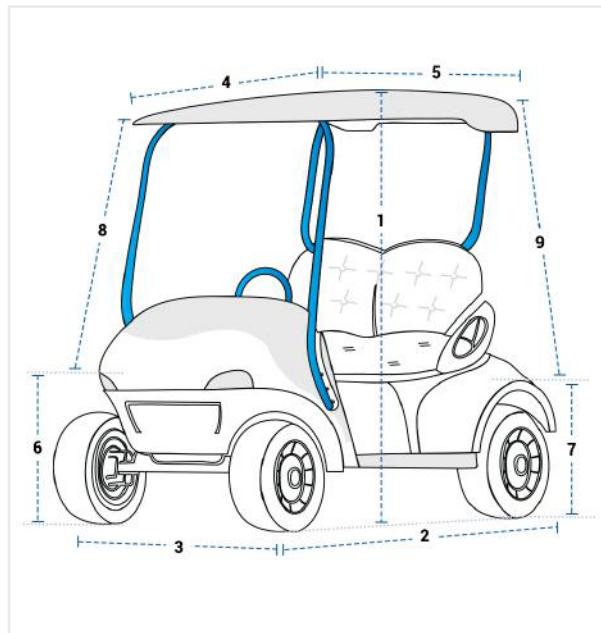

### Measurement (cm)

- |                 |                      |                 |                      |
|-----------------|----------------------|-----------------|----------------------|
| 1. Total Height | <input type="text"/> | 2. Depth        | <input type="text"/> |
| 3. Width        | <input type="text"/> | 4. Depth Top    | <input type="text"/> |
| 5. Top Width    | <input type="text"/> | 6. Front Height | <input type="text"/> |
| 7. Back Height  | <input type="text"/> | 8. Depth Left   | <input type="text"/> |
| 9. Depth Right  | <input type="text"/> |                 |                      |

**1. Total Height:**  
Height of the Tarp

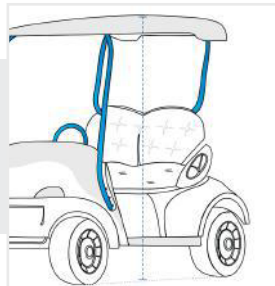

**2. Depth:**  
Depth of the Tarp

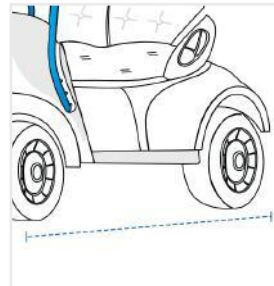

**3. Width:**  
Width of the Tarp

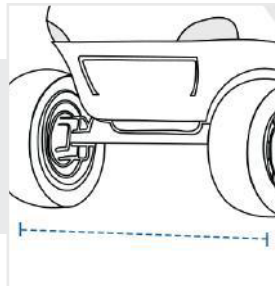

**4. Depth Top:**  
Width of the Tarp

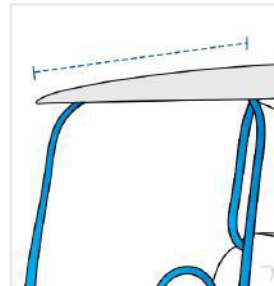

**5. Top Width:**  
Length of the Tarp

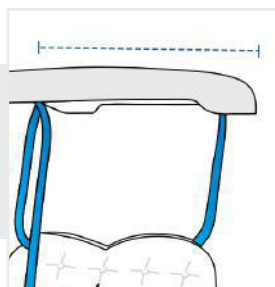

**6. Front Height:**  
Width of the Tarp

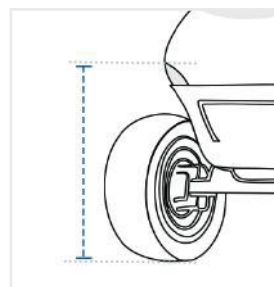

**7. Back Height:**  
Height of the Tarp

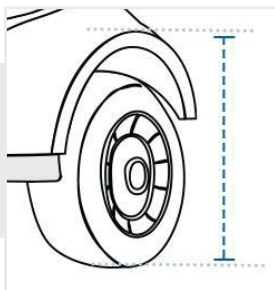

**8. Depth Left:**  
Width of the Tarp

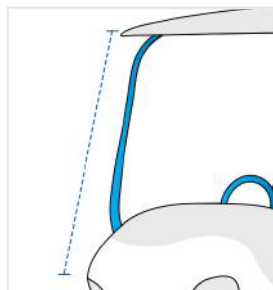

**9. Depth Right:**  
Height of the Tarp

