

How to Measure Fire Column Covers - Design 10

Measurement Instruction

- ✓ Give exact measurement from edge to edge.
- ✓ "We add upto 5 cm leeway on the given width/depth for easy pull-in and pull-out."
- ✓ The height dimensions will remain same as provided by you.

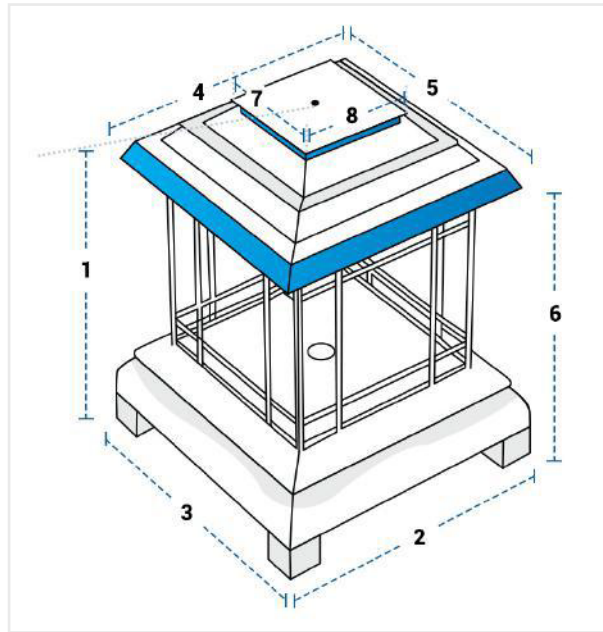

Measurement (cm)

1. Total Height	<input type="text"/>	2. Bottom Width	<input type="text"/>
3. Bottom Depth	<input type="text"/>	4. Width #1	<input type="text"/>
5. Depth #1	<input type="text"/>	6. Height #1	<input type="text"/>
7. Top Depth	<input type="text"/>	8. Top Width	<input type="text"/>

1. Total Height:
Total Height of the Fire Column

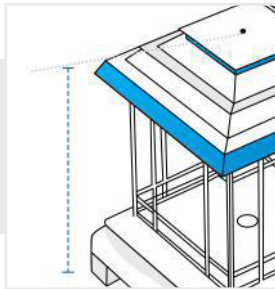

2. Bottom Width:
Bottom Width of the Fire Column

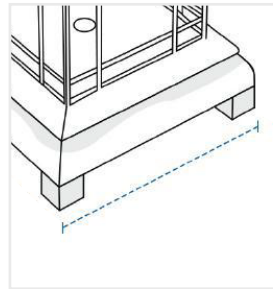

3. Bottom Depth:
Bottom Depth of the Fire Column

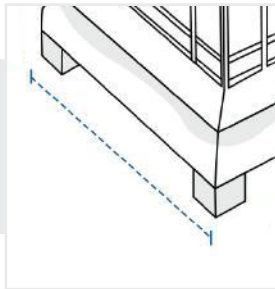

4. Width #1:
Width (Side #1) of the Fire Column

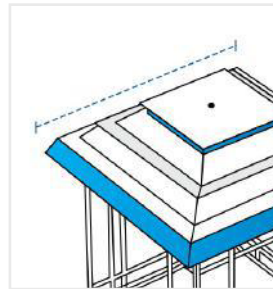

5. Depth #1:
Depth (Side #1) of the Fire Column

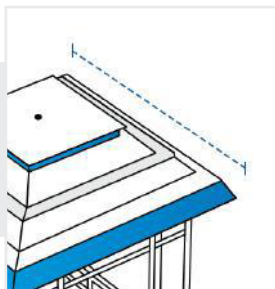

6. Height #1:
Height (Side #1) of the Fire Column

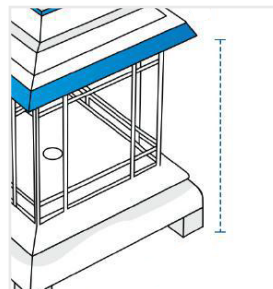

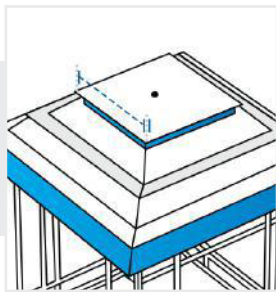

7. Top Depth:

Top Depth of the Fire Column

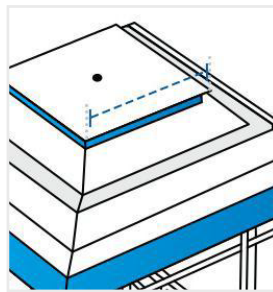

8. Top Width:

Top Width of the Fire Column

We encourage you to upload the image of the article you need the cover for - this helps our team ensure covers are designed keeping your requirements in mind.