

How to Measure Custom Winch Covers - Design 2

Measurement Instruction

- ✓ Give exact measurement from edge to edge.
- ✓ We add 2.5 to 5 cm leeway on the given width/depth for easy pull-in and pull-out.
- ✓ The height dimensions will remain same as provided by you.

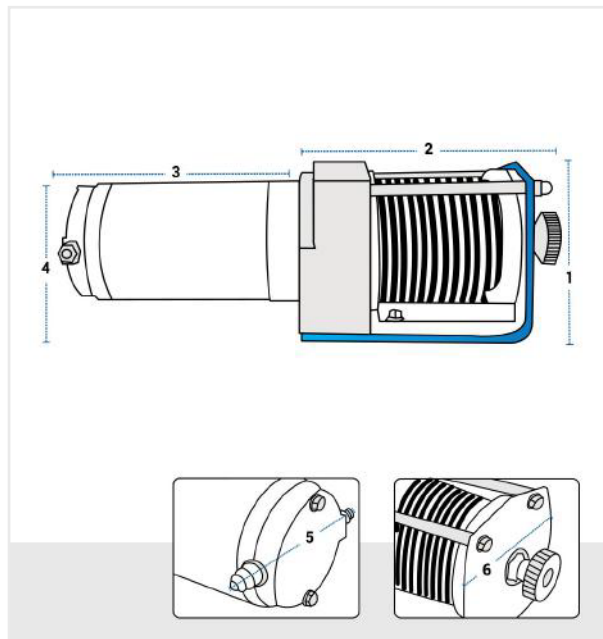

Measurement (cm)

1. Cable End Height	<input type="text"/>	2. Width till edge	<input type="text"/>
3. Width #1	<input type="text"/>	4. Other End Height	<input type="text"/>
5. Other End Depth	<input type="text"/>	6. Cable End Depth	<input type="text"/>

1. Cable End Height:

Cable End Height of the Custom Winch

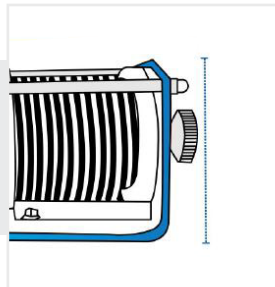

2. Width till edge:

Width till edge of the Custom Winch

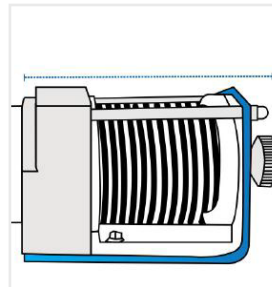

3. Width #1:

Width of the Custom Winch (Side #1)

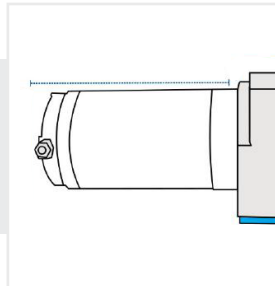

4. Other End Height:

Other End Height of the Custom Winch

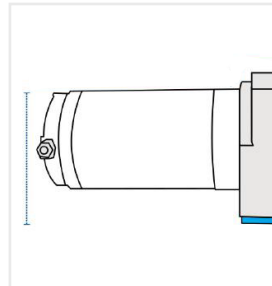

5. Other End Depth:

Other End Depth of the Custom Winch

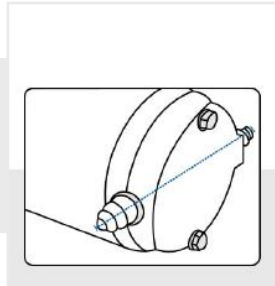

6. Cable End Depth:

Cable End Depth of Custom Winch

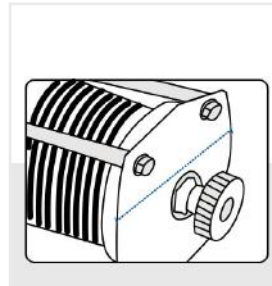

We encourage you to upload the image of the article you need the cover for - this helps our team ensure covers are designed keeping your requirements in mind.