

How to Measure Custom Winch Covers - Design 1

Measurement Instruction

- ✓ Give exact measurement from edge to edge.
- ✓ We add 2.5 to 5 cm leeway on the given width/depth for easy pull-in and pull-out.
- ✓ The height dimensions will remain same as provided by you.

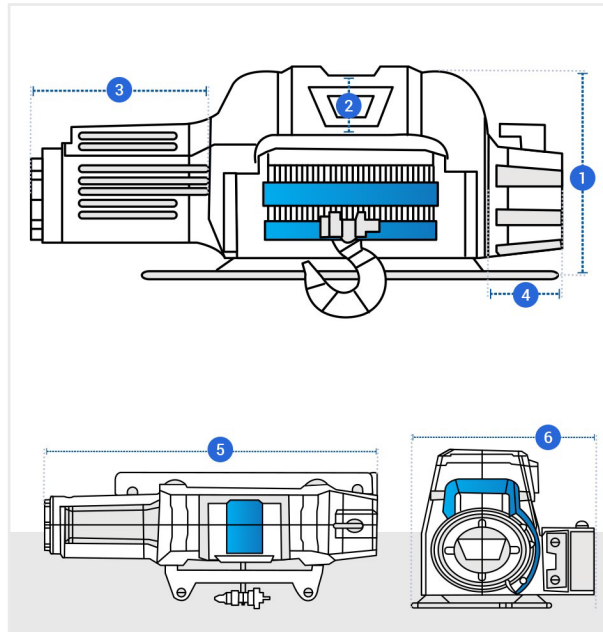

Measurement (cm)

1. Total Height	<input type="text"/>	2. Height #1	<input type="text"/>
3. Width #1	<input type="text"/>	4. Width #2	<input type="text"/>
5. Total Width	<input type="text"/>	6. Total Depth	<input type="text"/>

1. Total Height:
Total height of the Custom Winch

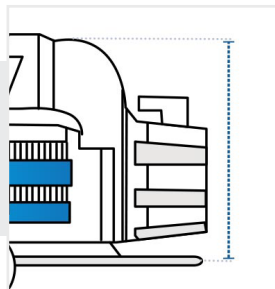

2. Height #1:
Height of Custom Winch (Side #1)

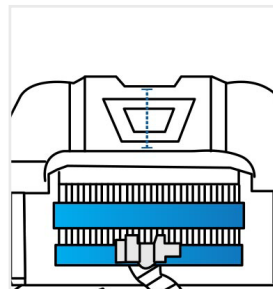

3. Width #1:
Width of Custom Winch (Side #1)

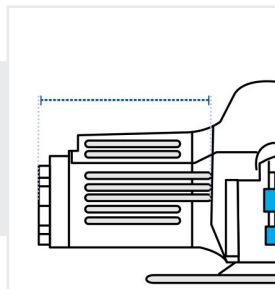

4. Width #2:
Width of Custom Winch (Side #2)

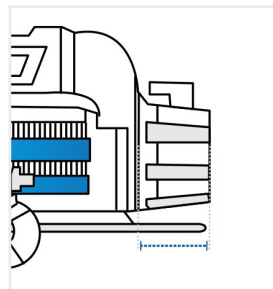

5. Total Width:
Total Width of the Custom Winch

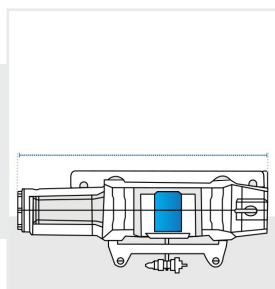

6. Total Depth:
Total Depth of the Custom Winch

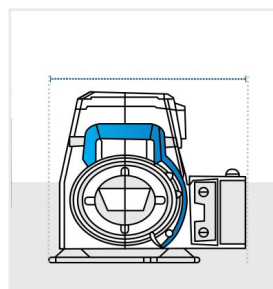

We encourage you to upload the image of the article you need the cover for - this helps our team ensure covers are designed keeping your requirements in mind.