

How to Measure Custom Pressure Washer Covers - Design 7

Measurement Instruction

- ✓ Give exact measurement from edge to edge.
- ✓ We add 2.5 to 5 cm leeway on the given width/depth for easy pull-in and pull-out.
- ✓ The height dimensions will remain same as provided by you.
- ✓ All measurements will be done in cm.

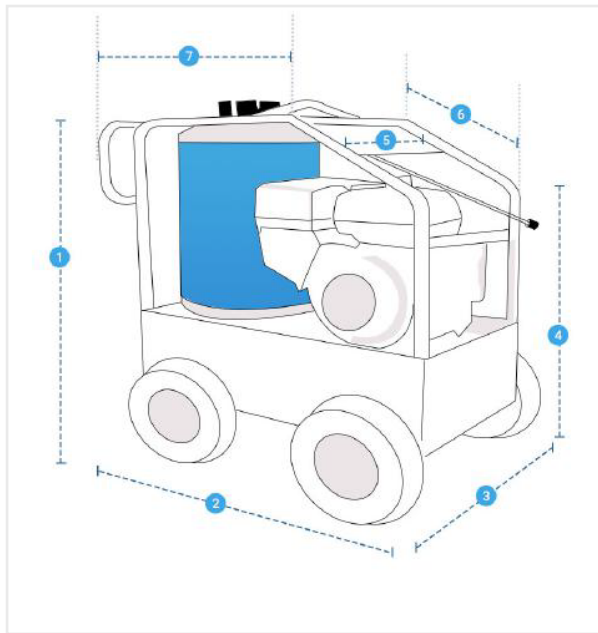

Measurement (cm)

- | | | | |
|------------------------------|----------------------|--------------------------|----------------------|
| 1. Back Height | <input type="text"/> | 2. Depth | <input type="text"/> |
| 3. Bottom Width | <input type="text"/> | 4. Front Height | <input type="text"/> |
| 5. Top Width | <input type="text"/> | 6. Slant Distance at Top | <input type="text"/> |
| 7. Straight Length till Back | <input type="text"/> | | |

1. Back Height:
Back Height of Pressure Washer

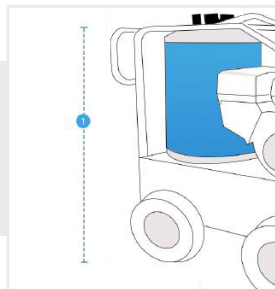

2. Depth:
Depth of Pressure Washer

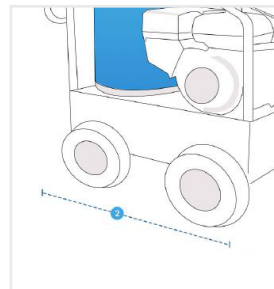

3. Bottom Width:
Bottom Width of Pressure Washer

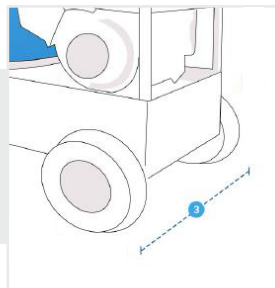

4. Front Height:
Front Height of Pressure Washer

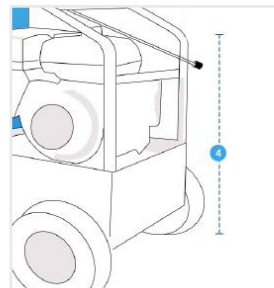

We encourage you to upload the image of the article you need the cover for - this helps our team ensure covers are designed keeping your requirements in mind.

How to Measure Custom Pressure Washer Covers - Design 7

Measurement Instruction

- ✓ Give exact measurement from edge to edge.
- ✓ We add 1" to 2" leeway on the given width/depth for easy pull-in and pull-out.
- ✓ The height dimensions will remain same as provided by you.
- ✓ All measurements will be done in inches.

5. Top Width:

Top Width of Pressure Washer

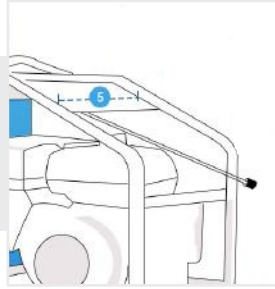

6. Slant Distance at Top

Slant Distance at Top of Pressure Washer

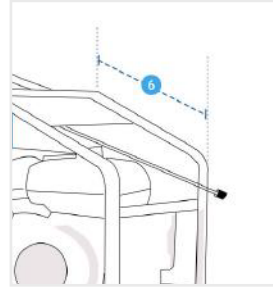

7. Straight Length till Back:

Straight Length till Back of Pressure Washer

