

# How to Measure Custom Log Splitter Covers - Electric Log Splitter

## Measurement Instruction

- ✓ Give exact measurement from edge to edge.
- ✓ We add 2.5 to 5 cm leeway on the given width/depth for easy pull-in and pull-out.
- ✓ The height dimensions will remain same as provided by you.
- ✓ All measurements will be done in cm.

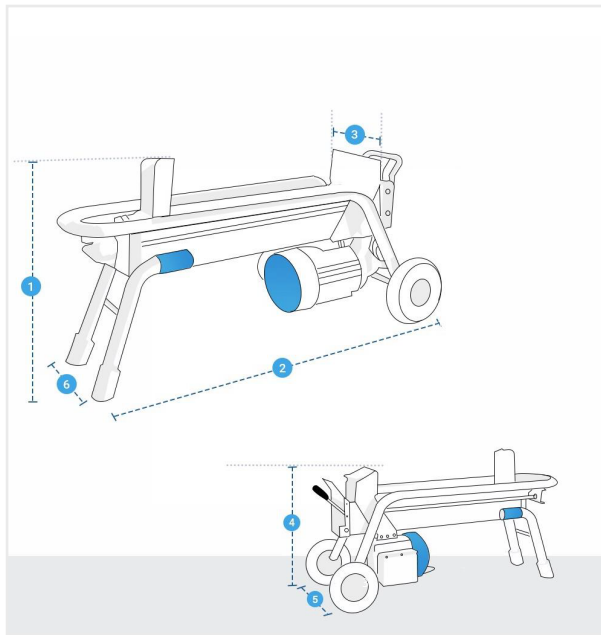

### Measurement (cm)

- |  |                      |                       |                      |
|--|----------------------|-----------------------|----------------------|
| 1. Height at front                     | <input type="text"/> | 2. Length             | <input type="text"/> |
| 3. Width at back                       | <input type="text"/> | 4. Height at back     | <input type="text"/> |
| 5. Width between tyres from outer edge | <input type="text"/> | 6. Width at the front | <input type="text"/> |

**1. Height at front:**  
Height at front of the Log Splitter

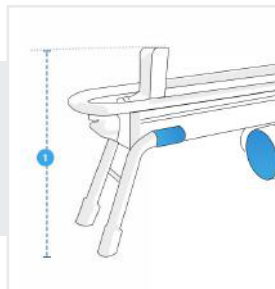

**2. Length:**  
Width of the Log Splitter

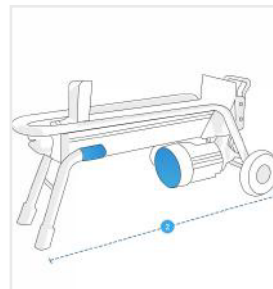

**3. Width at back:**  
Width at back of the Log Splitter

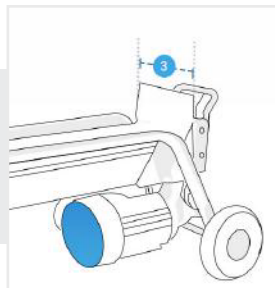

**4. Height at back:**  
Height at back of the Log Splitter

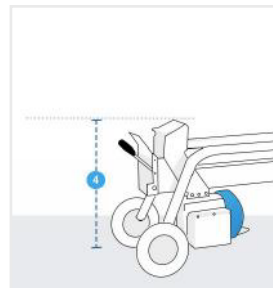

We encourage you to upload the image of the article you need the cover for - this helps our team ensure covers are designed keeping your requirements in mind.

## How to Measure Custom Log Splitter Covers - Electric Log Splitter

### Measurement Instruction

- ✓ Give exact measurement from edge to edge.
- ✓ We add 1" to 2" leeway on the given width/depth for easy pull-in and pull-out.
- ✓ The height dimensions will remain same as provided by you.
- ✓ All measurements will be done in inches.

#### 5. Width between tyres from outer edge:

Width between tyres from outer edge of the Log Splitter

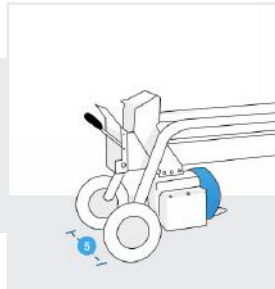

#### 6. Width at the front:

Width at the front of the Log Splitter

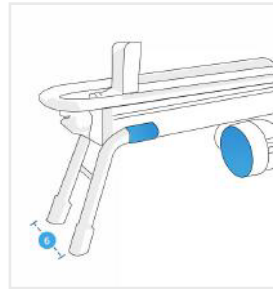

We encourage you to upload the image of the article you need the cover for - this helps our team ensure covers are designed keeping your requirements in mind.