

# How to Measure L Shape Sofa Cover

## Measurement Instruction

- ✓ Give exact measurement from edge to edge.
- ✓ We add 5 to 7.6 cm leeway on the given width/depth for easy pull-in and pull-out.
- ✓ The height dimensions will remain same as provided by you.

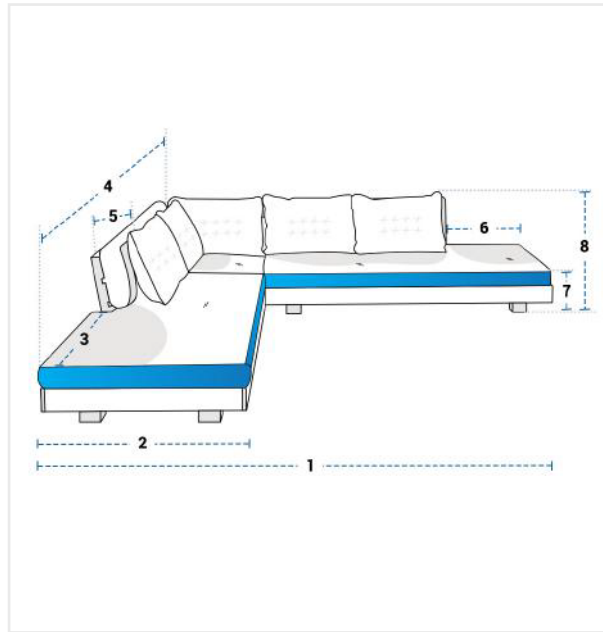

### Measurement (cm)

1. Total Length	<input type="text"/>	2. Length of Front - Left	<input type="text"/>
3. Length upto Back Rest - Left	<input type="text"/>	4. Length of Back - Left	<input type="text"/>
5. Depth of Back Rest Incl Cushion	<input type="text"/>	6. Length of Back - Right	<input type="text"/>
7. Front Height	<input type="text"/>	8. Total Height	<input type="text"/>

**1. Total Length:**  
Total Length of the L Shape Sofa Cover

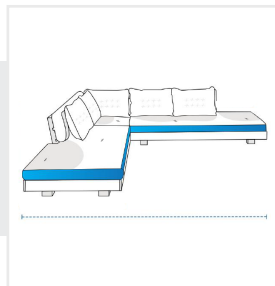

**2. Length of Front - Left:**  
Length of Front - Left of the L Shape Sofa Cover

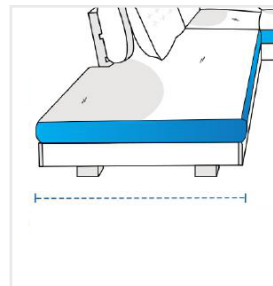

**3. Length upto Back Rest - Left:**  
Length upto Back Rest - Left of the L Shape Sofa Cover

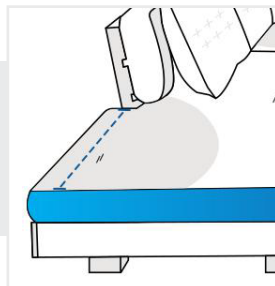

**4. Length of Back - Left:**  
Length of Back - Left of the L Shape Sofa Cover

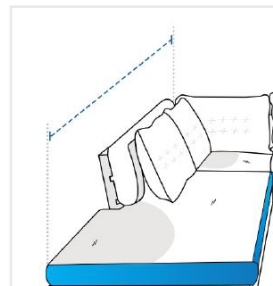

**5. Depth of Back Rest Incl Cushion:**  
Depth of Back Rest Incl Cushion of the L Shape Sofa Cover

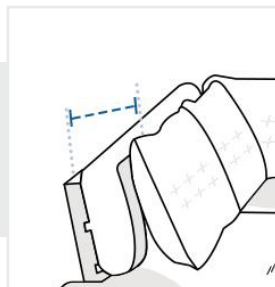

**6. Length of Back - Right:**  
Length of Back - Right of the L Shape Sofa Cover

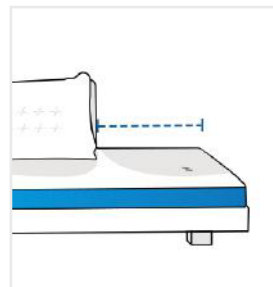

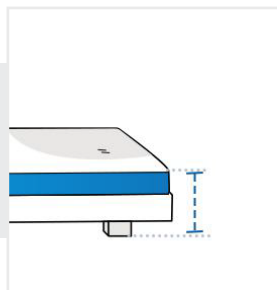

**7. Front Height:**  
Front Height of the  
L Shape Sofa Cover

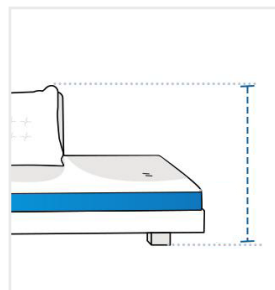

**8. Total Height:**  
Total Height of the  
L Shape Sofa Cover