

# How to Measure Custom Gas Snowblower Cover

## Measurement Instruction

- ✓ Give exact measurement from edge to edge.
- ✓ We add 2.5 to 5 cm leeway on the given width/depth for easy pull-in and pull-out.
- ✓ The height dimensions will remain same as provided by you.

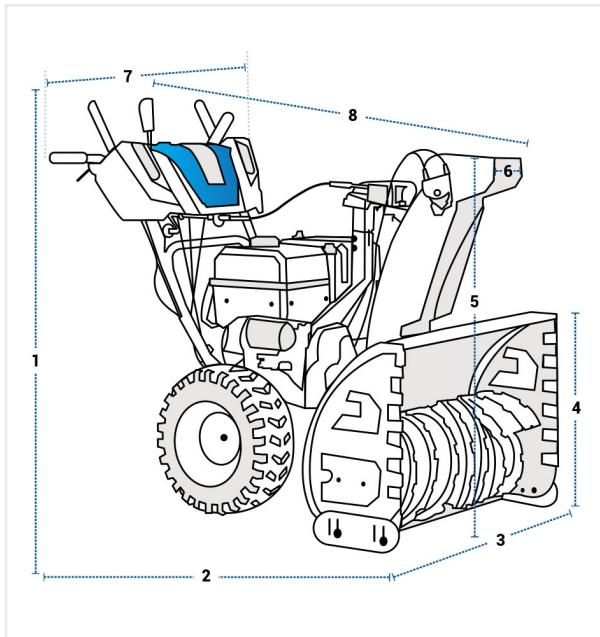

### Measurement (cm)

1. Back Height	<input type="text"/>	2. Depth	<input type="text"/>
3. Front Width	<input type="text"/>	4. Front Height #1	<input type="text"/>
5. Front Height	<input type="text"/>	6. Chute Width	<input type="text"/>
7. Back Width	<input type="text"/>	8. Depth #1	<input type="text"/>

**1. Back Height:**  
Back Height of the Custom Gas Snowblower

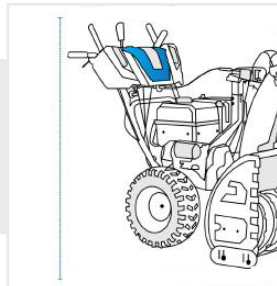

**2. Depth:**  
Depth of the Custom Gas Snowblower

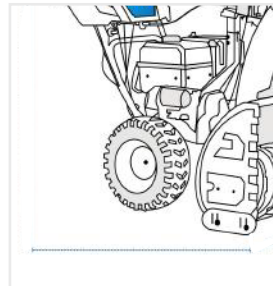

**3. Front Width:**  
Front Width of the Custom Gas Snowblower

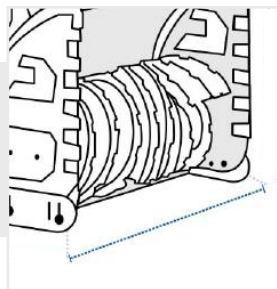

**4. Front Height #1:**  
Front Height (Side #1)

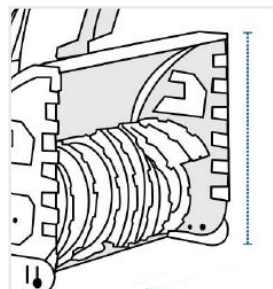

**5. Front Height:**  
Front Height of the Custom Gas Snowblower

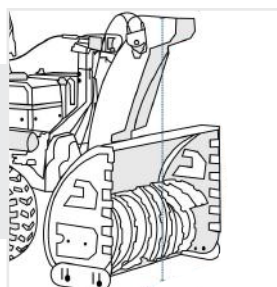

**6. Chute Width:**  
Chute Width of the Custom Gas Snowblower

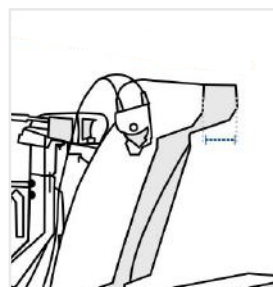

## 7. Back Width:

Back Width of the  
Custom Gas Snowblower

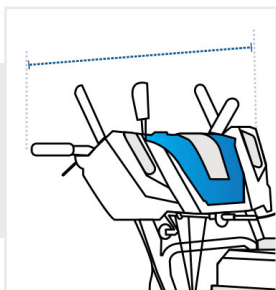

## 8. Depth #1:

Depth of the Gas  
Snowblower(Side #1)

