

## How to Measure Custom Covers - Design 6

### Measurement Instruction

- ✓ Give exact measurement from edge to edge.
- ✓ "We add upto 5 cm leeway on the given width/depth for easy pull-in and pull-out."
- ✓ The height dimensions will remain same as provided by you.

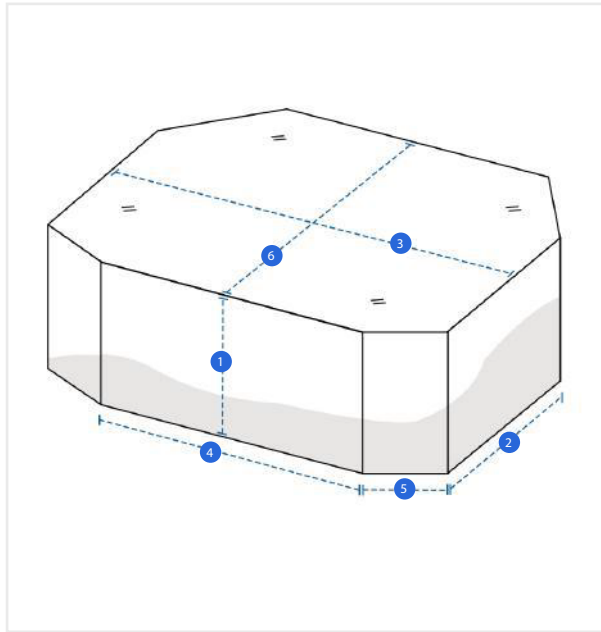

### Measurement (cm)

1. Height	<input type="text"/>	2. Depth #1	<input type="text"/>
3. Width #1	<input type="text"/>	4. Width #2	<input type="text"/>
5. Corner Depth	<input type="text"/>	6. Depth #2	<input type="text"/>

**1. Height:**  
Height of the Product

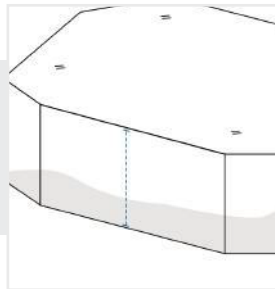

**2. Depth #1:**  
Depth #1 of the Product

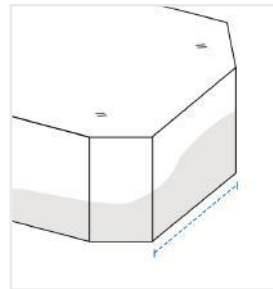

**3. Width #1:**  
Width #1 of the Product

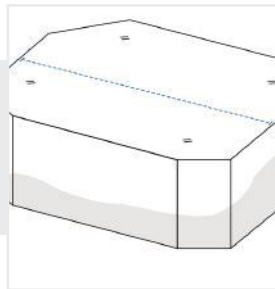

**4. Width #2:**  
Width #2 of the Product

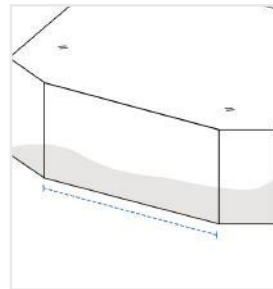

**5. Corner Depth:**  
Corner Depth of the Product

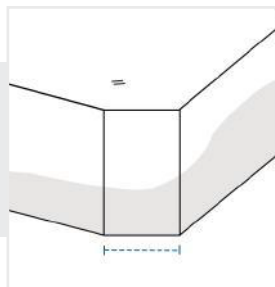

**6. Depth #2:**  
Depth #2 of the Product

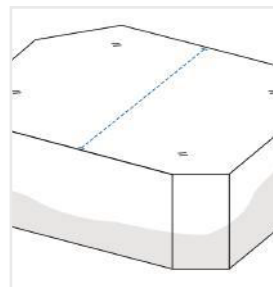

We encourage you to upload the image of the article you need the cover for - this helps our team ensure covers are designed keeping your requirements in mind.