

How to Measure Custom Concession Display Cover – Design 3

Measurement Instruction

- ✓ Give exact measurement from edge to edge.
- ✓ We add 2.5 to 5 cm leeway on the given width/depth for easy pull-in and pull-out.
- ✓ The height dimensions will remain same as provided by you.

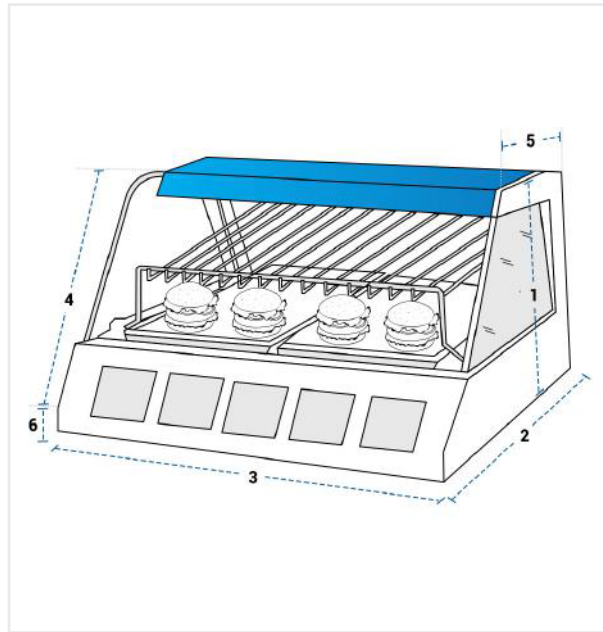

Measurement (cm)

1. Back Height	<input type="text"/>	2. Bottom Depth	<input type="text"/>
3. Width	<input type="text"/>	4. Slant Height	<input type="text"/>
5. Top Depth	<input type="text"/>	6. Front Height	<input type="text"/>

1. Back Height:
Back Height of the Custom Concession Display

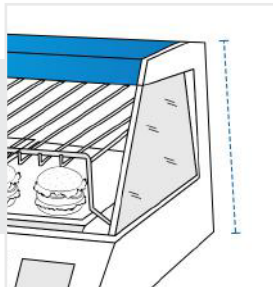

2. Bottom Depth:
Bottom Depth of the Custom Concession Display

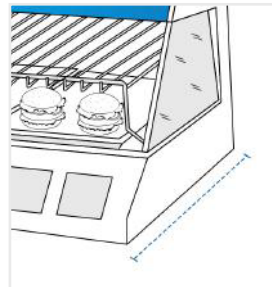

3. Width:
Width of the Custom Concession Display

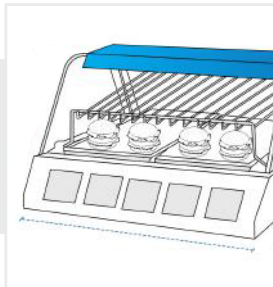

4. Slant Height:
Slant Height of the Custom Concession Display

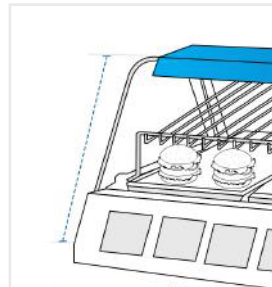

5. Top Depth:
Top Depth of the Custom Concession Display

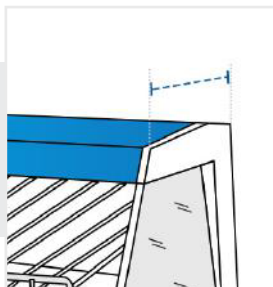

6. Front Height:
Front Height of the Custom Concession Display

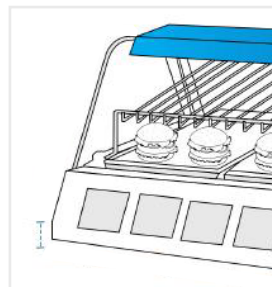

We encourage you to upload the image of the article you need the cover for - this helps our team ensure covers are designed keeping your requirements in mind.