

# How to Measure Custom Concession Display Cover – Design 1

## Measurement Instruction

- ✓ Give exact measurement from edge to edge.
- ✓ We add 2.5 to 5 cm leeway on the given width/depth for easy pull-in and pull-out.
- ✓ The height dimensions will remain same as provided by you.

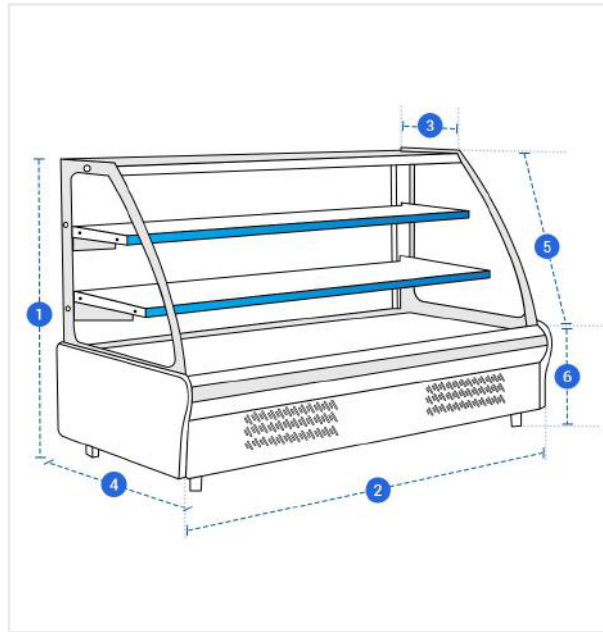

### Measurement (cm)

1. Back Height	<input type="text"/>	2. Width	<input type="text"/>
3. Upper Depth	<input type="text"/>	4. Bottom Depth	<input type="text"/>
5. Slant Height	<input type="text"/>	6. Front Height	<input type="text"/>

**1. Back Height:**  
Back Height of the Custom Concession Display

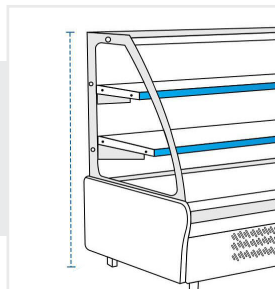

**2. Width:**  
Width of the Custom Concession Display

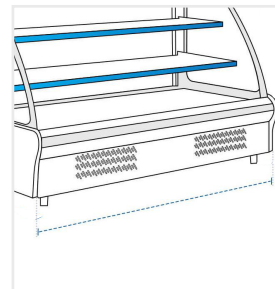

**3. Upper Depth:**  
Upper Depth of the Custom Concession Display

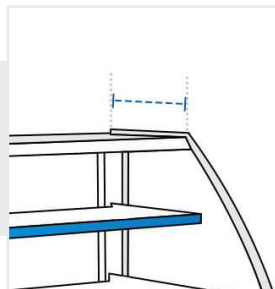

**4. Bottom Depth:**  
Bottom Depth of the Custom Concession Display

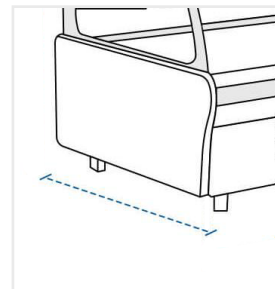

**5. Slant Height:**  
Slant Height of the Custom Concession Display

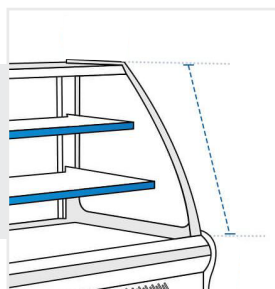

**6. Front Height:**  
Front Height of the Custom Concession Display

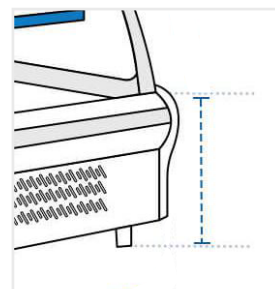

We encourage you to upload the image of the article you need the cover for - this helps our team ensure covers are designed keeping your requirements in mind.