

How to Measure Custom Chimney Cover - Design 8

Measurement Instruction

- ✓ Give exact measurement from edge to edge.
- ✓ We add 2.5 to 5 cm leeway on the given width/depth for easy pull-in and pull-out.
- ✓ The height dimensions will remain same as provided by you.

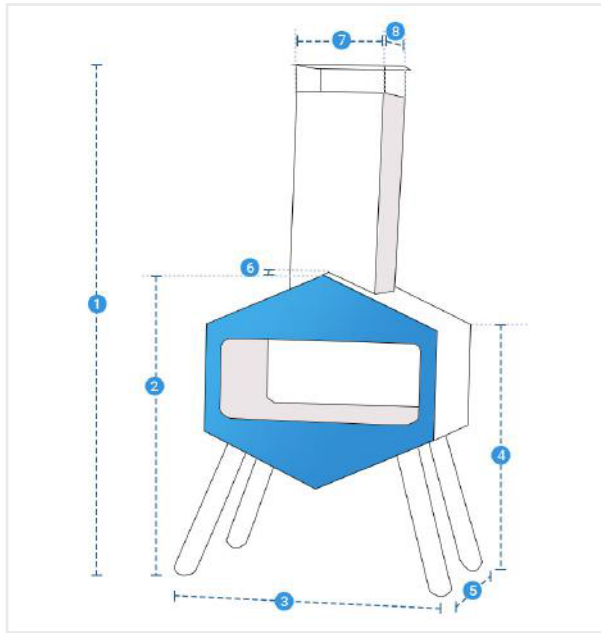

Measurement (cm)

1. Height	<input type="text"/>	2. Height till Chimney Pipe Bottom	<input type="text"/>
3. Bottom Width	<input type="text"/>	4. Height till Edge	<input type="text"/>
5. Bottom Depth	<input type="text"/>	6. Depth from Chimney Pipe	<input type="text"/>
7. Width of Chimney Pipe	<input type="text"/>	8. Depth of Chimney Pipe	<input type="text"/>

1. Height:
Height of the Custom Chimney

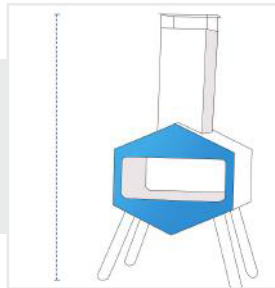

2. Top Hexagonal Slant Length 1:
Top Hexagonal Slant Length 1 of the Custom Chimney

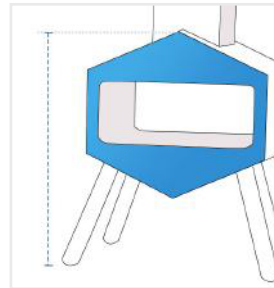

3. Bottom Width:
Bottom Width of the Custom Chimney

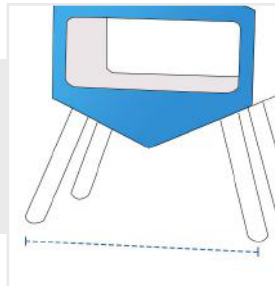

4. Height till Edge:
Height till Edge of the Custom Chimney

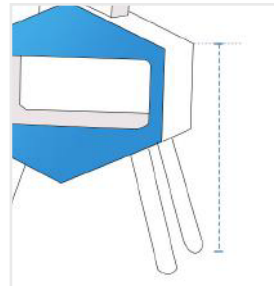

5. Bottom Depth:
Bottom Depth of the Custom Chimney

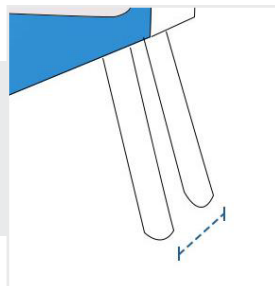

6. Depth from Chimney Pipe:
Depth from Chimney Pipe of the Custom Chimney

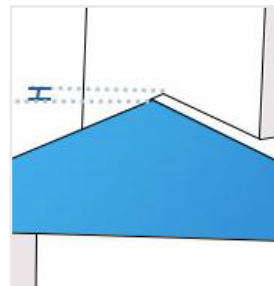

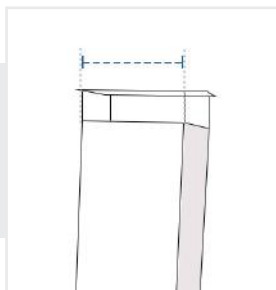

7. Width of Chimney Pipe:

Width of Chimney Pipe of the Custom Chimney

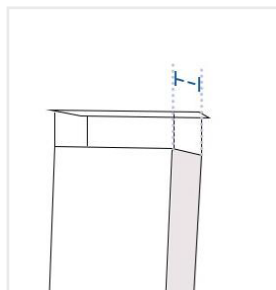

8. Depth of Chimney Pipe:

Depth of Chimney Pipe of the Custom Chimney