

How to Measure Custom Chimney Cover - Design 6

Measurement Instruction

- ✓ Give exact measurement from edge to edge.
- ✓ We add 2.5 to 5 cm leeway on the given width/depth for easy pull-in and pull-out.
- ✓ The height dimensions will remain same as provided by you.

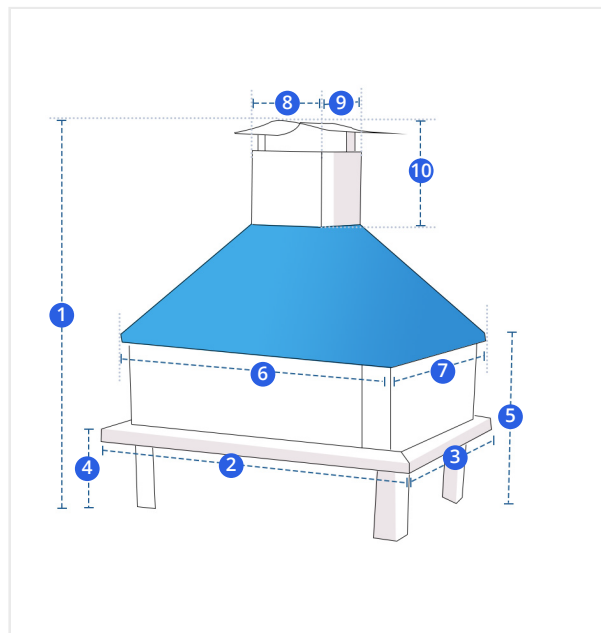

Measurement (cm)

1. Height	<input type="text"/>	2. Bottom Width	<input type="text"/>
3. Bottom Depth	<input type="text"/>	4. Height#1	<input type="text"/>
5. Height#2	<input type="text"/>	6. Top Width	<input type="text"/>
7. Top Depth	<input type="text"/>	8. Width of Chimney Pipe	<input type="text"/>
9. Depth of Chimney Pipe	<input type="text"/>	10. Height of Chimney Pipe	<input type="text"/>

1. Height:
Height of the Custom Chimney

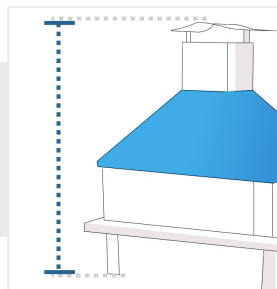

2. Bottom Width:
Bottom Width of the Custom Chimney

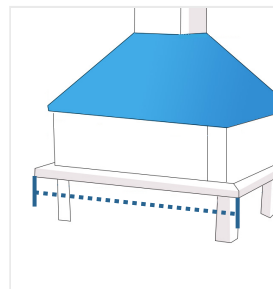

3. Bottom Depth:
Bottom Depth of the Custom Chimney

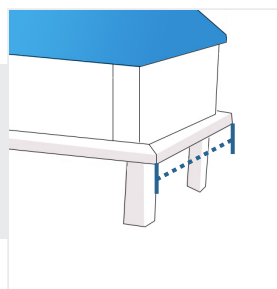

4. Height#1:
Height#1 of the Custom Chimney

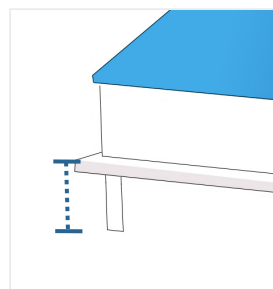

5. Height#2:
Height#2 of the Custom Chimney

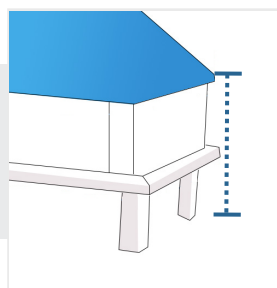

6. Top Width:
Top Width of the Custom Chimney

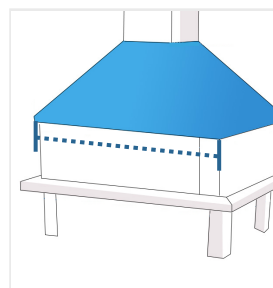

7. Top Depth:

Top Depth of the Custom Chimney

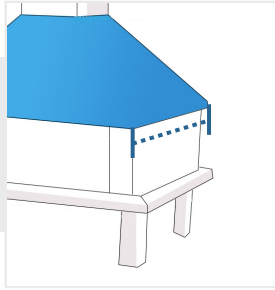

8. Width of Chimney Pipe:

Width of Chimney Pipe of the Custom Chimney

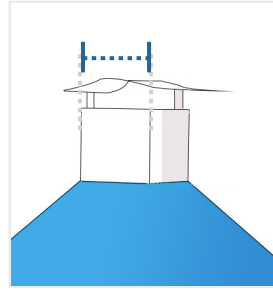

9. Depth of Chimney Pipe:

Depth of Chimney Pipe of the Custom Chimney

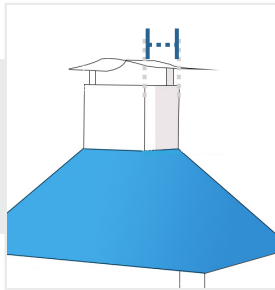

10. Height of Chimney Pipe:

Height of Chimney Pipe of the Custom Chimney

