

# How to Measure Custom Chimney Cover - Design 2

## Measurement Instruction

- ✓ Give exact measurement from edge to edge.
- ✓ We add 2.5 to 5 cm leeway on the given width/depth for easy pull-in and pull-out.
- ✓ The height dimensions will remain same as provided by you.

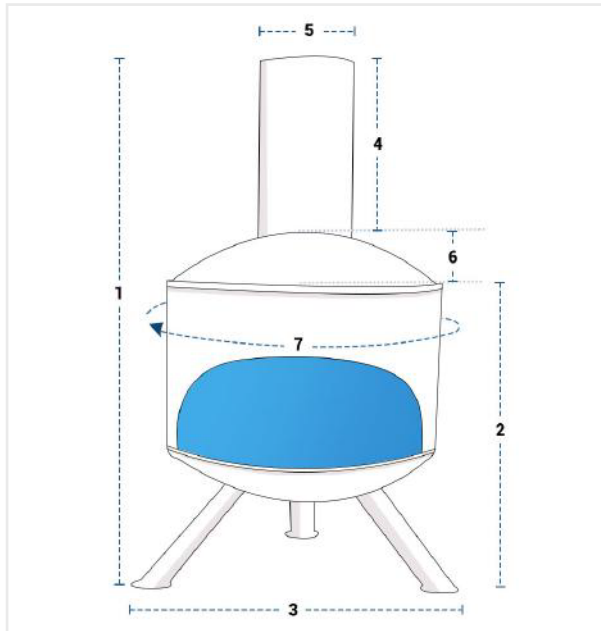

### Measurement (cm)

1. Height	<input type="text"/>	2. Height till Edge	<input type="text"/>
3. Width	<input type="text"/>	4. Height of Chimney Pipe	<input type="text"/>
5. Chimney Pipe Diameter	<input type="text"/>	6. Length of Pipe End to Edge	<input type="text"/>
7. Heat Chamber Circumference	<input type="text"/>		

**1. Total Height:**  
Total Height of the Custom Chimney Design 2

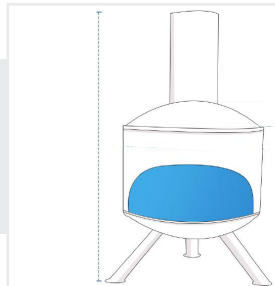

**2. Height till Edge:**  
Height till Edge of the Custom Chimney Design 2

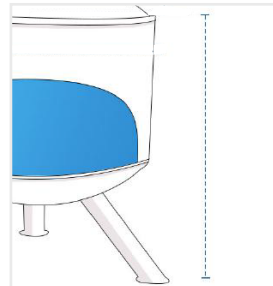

**3. Width:**  
Width of the Custom Chimney Design 2

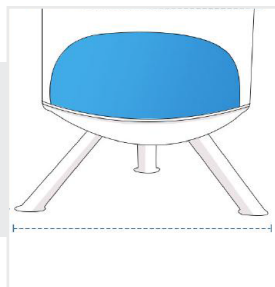

**4. Height of Chimney Pipe:**  
Height of Chimney Pipe of the Custom Chimney Design 2

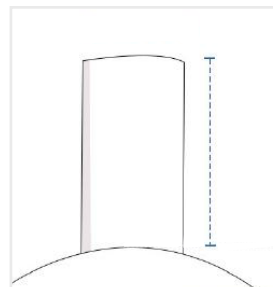

**5. Chimney Pipe Diameter:**  
Chimney Pipe Diameter of the Custom Chimney Design 2

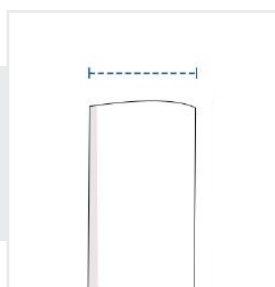

**6. Length of Pipe End to Edge:**  
Length of Pipe End to Edge of the Custom Chimney Design 2

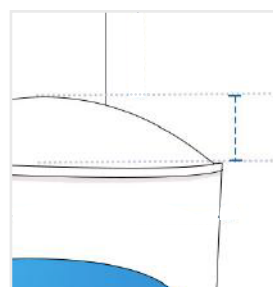

**7. Heat Chamber Circumference :**  
Heat Chamber Circumference of the  
Custom Chimney Design 2

