

# How to Measure Chaise Lounge Covers - Design 2

## Measurement Instruction

- ✓ Give exact measurement from edge to edge.
- ✓ "We add upto 5 cm leeway on the given width/depth for easy pull-in and pull-out."
- ✓ The height dimensions will remain same as provided by you.

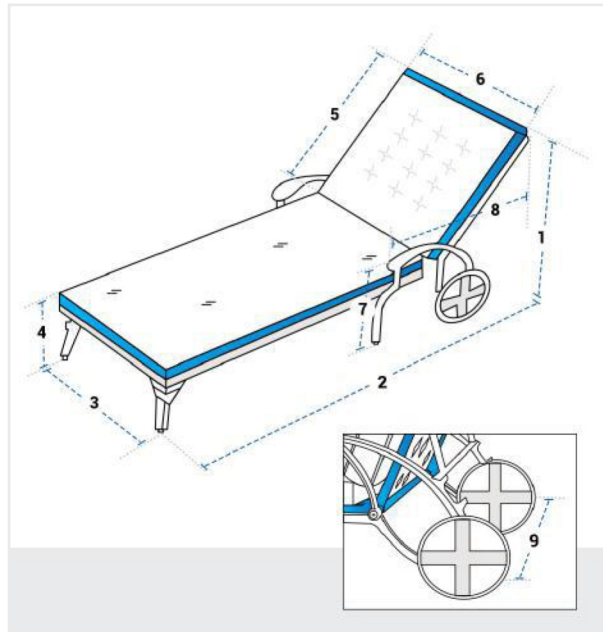

### Measurement (cm)

1. Back Height	<input type="text"/>	2. Total Depth	<input type="text"/>
3. Front Width	<input type="text"/>	4. Front Height	<input type="text"/>
5. Slant Height	<input type="text"/>	6. Top Width	<input type="text"/>
7. Arm Height	<input type="text"/>	8. Arm Depth	<input type="text"/>
9. Wheel to Wheel Width	<input type="text"/>		

**1. Back Height:**  
Back Height of the Chaise

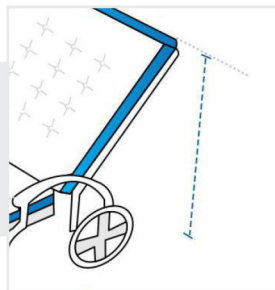

**2. Total Depth:**  
Total Depth of the Chaise

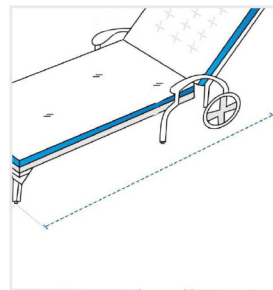

**3. Front Width:**  
Front Width of the Chaise

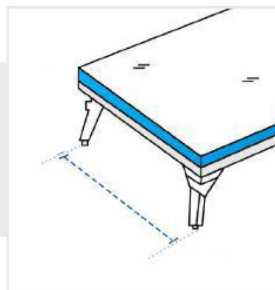

**4. Front Height:**  
Front Height of the Chaise

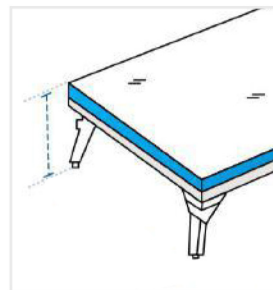

**5. Slant Height:**  
Slant Height of the Chaise

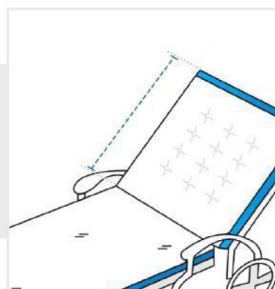

**6. Top Width :**  
Top Width of the Chaise

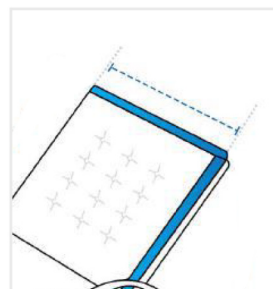

**7. Arm Height:**  
Arm Height of the Chaise

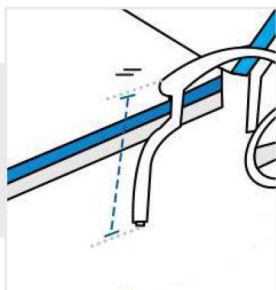

**8. Arm Depth:**  
Arm Depth of the Chaise

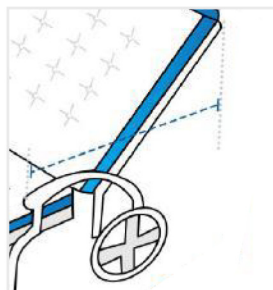

**9. Wheel to Wheel Width:**  
Wheel to Wheel Width of the Chaise

