

How to Measure Custom Adirondack Chair Covers - Design 3

Measurement Instruction

- ✓ Give exact measurement from edge to edge.
- ✓ We add 2.5 to 5 cm leeway on the given width/depth for easy pull-in and pull-out.
- ✓ The height dimensions will remain same as provided by you.

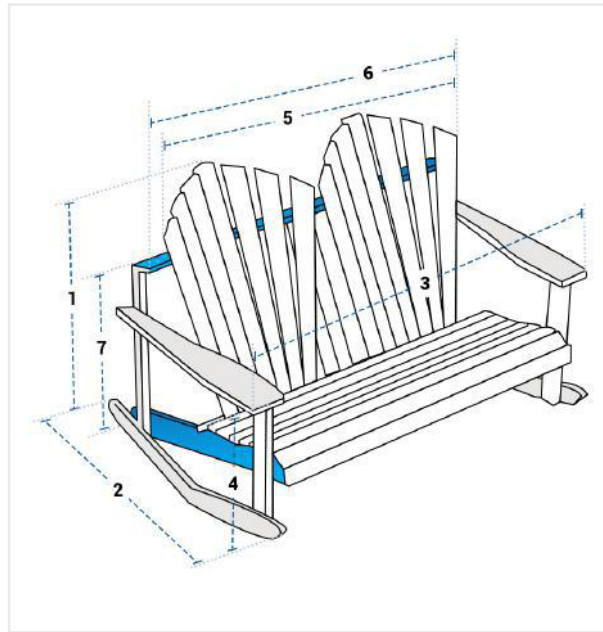

Measurement (cm)

1. Back Height

2. Depth

3. Arm to Arm Width

4. Front Height

5. Back Width

6. Width #1

7. Height #1

1. Back Height:
Back Height of the Custom Adirondack Chair

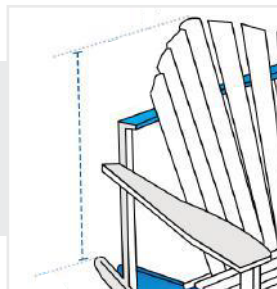

2. Depth:
Depth of the Custom Adirondack Chair

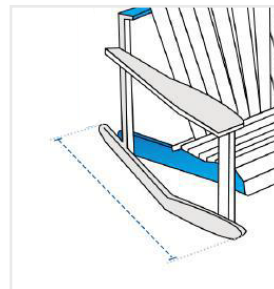

3. Arm to Arm Width:
Arm to Arm Width of the Custom Adirondack Chair

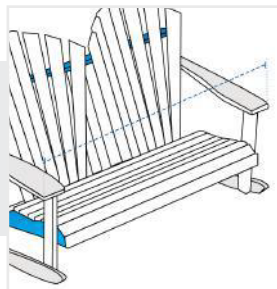

4. Front Height:
Front Height of the Custom Adirondack Chair

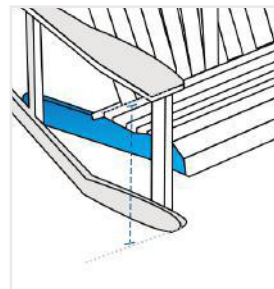

5. Back Width:
Back Width of the Custom Adirondack Chair

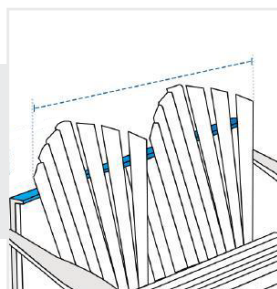

6. Width #1:
Width (side #1)

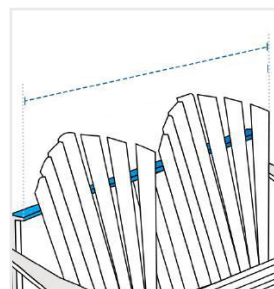

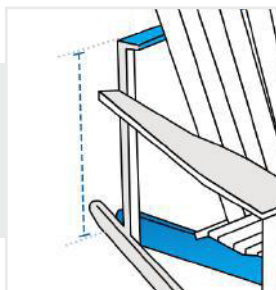

7. Height #1:
Height (Side#1)

We encourage you to upload the image of the article you need the cover for - this helps our team ensure covers are designed keeping your requirements in mind.